

1	2	3	4	5	6	7	8	
页数(Page No.)	1/1	Used By:	HRB	Version 版次	Engineer Change No ECN编码	Change Description 变更描述	Date 日期	Approved by 签核
				A	---	Initial release	08/18-'21	Feiyi

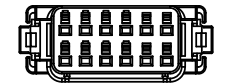
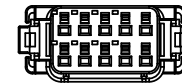
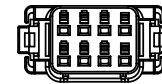
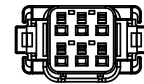
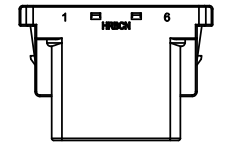
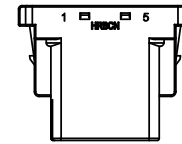
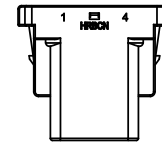
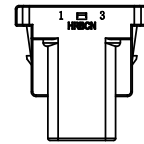
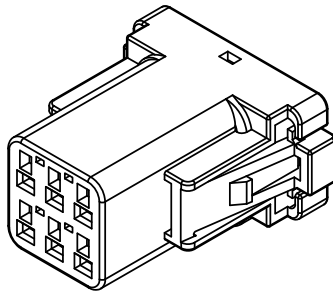
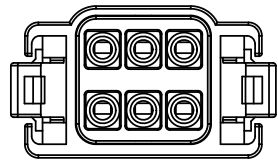

2x3 Pin

2x4 Pin

2x5 Pin

2x6 Pin

Circuit No.

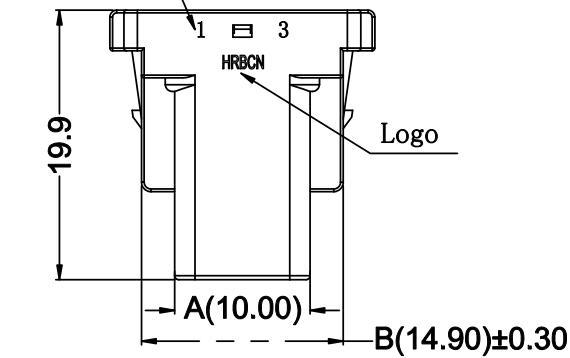

3D View  
2x3 Pin

NOTES

\*Material

- Housing: PBT UL94V-0;
- Seal plug: Silicon rubber;
- Seal plug holder :PBT UL94V-0;
- Contacts: Copper Alloy;
- Contact Plating: Tin Plating Over Ni On Contact Area
- Used With: T30032WPPS-2
- Mated With: M30033WP-NxN-W

\*Electrical Specification

- Current Rating: 10A AC,DC Max. (AWG18)
- Voltage Rating: 250V AC,DC
- Operating Temperature: -40℃~+130℃
- Insulation Resistance: 1000MΩ Min.
- Withstanding Voltage: 1500V AC/minute
- Waterproof Grade: IP67

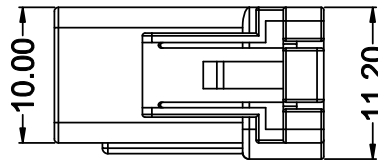
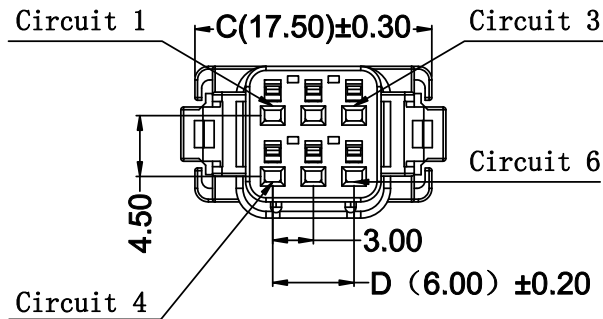

Pin No.	料号	A	B	C	D
2x2	M30032WP-2x2-W	7.00	11.90	14.30	3.00
2x3	M30032WP-2x3-W	10.00	14.90	17.30	6.00
2x4	M30032WP-2x4-W	13.00	17.90	20.30	9.00
2x5	M30032WP-2x5-W	16.00	20.90	23.30	12.00
2x6	M30032WP-2x6-W	19.00	23.90	26.30	15.00

料号 (Part No.)	M30032WP-NxN-W	UNIT:mm	
产品名称 (Product Name)	Water Proof 3.0 Pitch Male (NxN) Pin	Tolerance: .XXX ±0.10 .XX ±0.20 .X ±0.30	Angular Dim. .XX° ±1° .X° ±2° X.° ±3°
比例(Scale)	1:1	版本(Version)	A



东莞市鸿儒连接器有限公司  
Hong Ru Connectors(DG) Co.,Ltd.

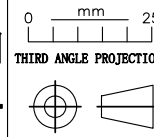

核准 Approved:		日期 Date:	08/18-'21
审核 Checked:		日期 Date:	08/18-'21
设计 Designed:	Feiyi	日期 Date:	08/18-'21